

Sensor Flexibility

Flexibility — that is why plant maintenance professionals choose Electro-Sensors' Speed Monitoring Sensors and Shaft Speed Switches. For example, you only need a ruler to position our sensing heads (with our competitors you need a feeler gauge). Compare our sensor tolerances to competitors before you purchase and install an inflexible rotational pickup device. Other product features include:

Pulser Disc Position and Tolerance

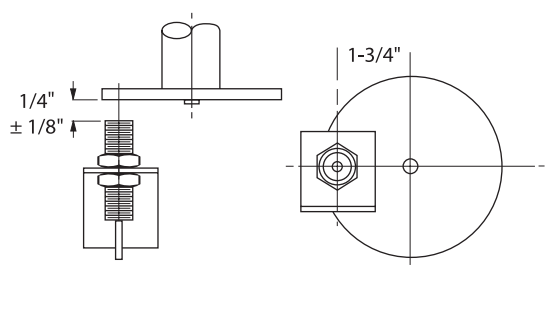

Pulser Wrap Position and Tolerance

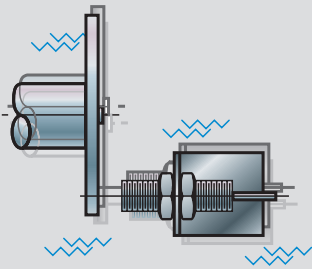
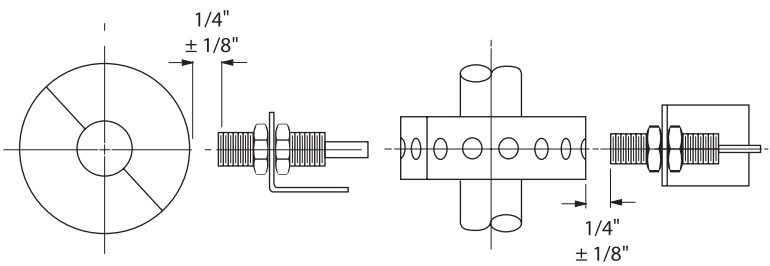

Unaffected by plant vibration

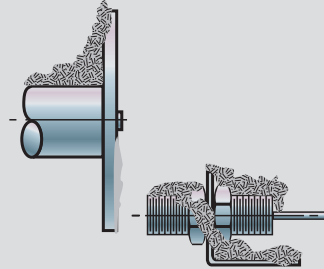

Plows through grease, dust & dirt

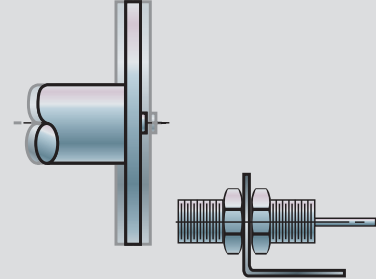

Forgives up to 1/8 inch end play

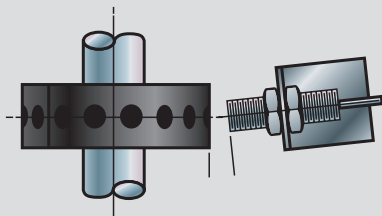

Forgives misalignment

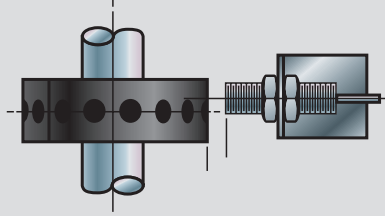

Senses up to 1/4 inch off center

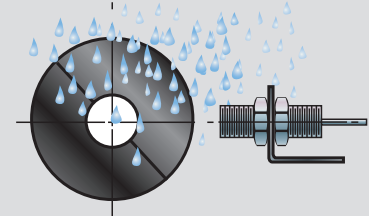

Water resistant